

# Structures Data Book

**1999 Edition**

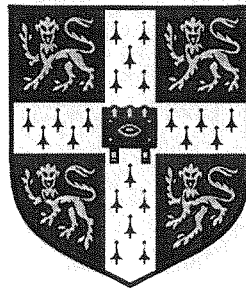

**Cambridge University Engineering Department**

## Table of Contents

<b>1. Physical properties of structural materials</b>	<b>1</b>
<b>2. Stress and strain</b>	<b>1</b>
2.1. Notation for stress.....	1
2.2. Strain definition .....	1
2.3. Stress-strain relations for isotropic elastic solids.....	1
2.4. Complementary shear .....	2
2.5. Planar transformation equations for stress.....	2
2.6. Mohr's circle of stress .....	2
2.7. Planar transformation equations for strain.....	3
2.8. Mohr's circle of strain .....	3
2.9. Principal stresses in 3 dimensions .....	4
2.10. Yield criteria for isotropic solids .....	4
<b>3. Beam behaviour</b>	<b>4</b>
3.1. CUED sign convention .....	4
3.2. Compatibility .....	4
3.3. Equilibrium .....	5
3.4. Elastic bending formulae .....	5
3.5. Formulae for elastic analysis .....	6
3.6. Plastic bending .....	7
3.7. Torsion formulae.....	7
<b>4. Euler buckling</b>	<b>8</b>
<b>5. Pin-jointed trusses – statical determinacy</b>	<b>8</b>
<b>6. Equation of virtual work</b>	<b>8</b>
<b>7. Soil mechanics</b>	<b>9</b>
7.1. Definitions .....	9
7.2. Classification of particle sizes .....	9
7.3. Groundwater seepage.....	10
7.4. Stresses in soils .....	10
7.5. Strength of soil: Cohesion hypothesis (Tresca).....	11
7.6. Friction hypothesis (Coulomb) .....	11
<b>8. Typical properties and forms of structural materials</b>	<b>11</b>
8.1. Mechanical properties of steel and aluminium .....	11
8.2. Mechanical properties of glass fibre reinforced plastic (GFRP) .....	11
8.3. Structural steel sections (hot-rolled).....	12
8.4. Aluminium sections (extrusions).....	20
8.5. Glass fibre reinforced plastic (GFRP) sections (pultrusions) .....	22

# 1. Physical properties of structural materials

Values to be used in calculations (further details in Materials Data Book and Section 8)

		Steel	Aluminium Alloy	Concrete*	Softwood* along grain	Water	units
Young's modulus	$E$	210	70	30	9	-	GPa
Shear modulus	$G$	81	26	13	-	-	GPa
Bulk modulus	$K$	175	69	14	-	2.2	GPa
Poisson's ratio	$\nu$	0.30	0.33	0.15	-	-	
Thermal expansion	$\alpha$	11	23	12	-	60	$\times 10^{-6} \text{ K}^{-1}$
Density	$\rho$	7840	2700	2400	-	1000	$\text{kg/m}^3$

\* Typical values

For isotropic solids,

$$G = \frac{E}{2(1+\nu)}; \quad K = \frac{E}{3(1-2\nu)}$$

## 2. Stress and strain

### 2.1. Notation for stress

$\sigma_{xx}$  is the normal stress on the  $x$  face acting in the  $x$  direction.

$\tau_{xy}$  is the shear stress on the  $x$  face acting in the  $y$  direction.

In this data book, with the exception of Section 7, tensile stresses are defined as positive.

### 2.2. Strain definition

$\varepsilon_{xx}$  is the normal strain in the  $x$  direction.

$\gamma_{xy}$  is the shear strain between the  $x$  and  $y$  faces.

$$\varepsilon_{xx} = \frac{\partial u}{\partial x}; \quad \gamma_{xy} = \frac{\partial u}{\partial y} + \frac{\partial v}{\partial x} \quad \text{etc.}$$

where:  $u, v$  are small displacement components with respect to rectangular co-ordinates  $x, y$ .

### 2.3. Stress-strain relations for isotropic elastic solids

$$\varepsilon_{xx} = \frac{1}{E}(\sigma_{xx} - \nu\sigma_{yy} - \nu\sigma_{zz}) + \alpha\Delta T \quad \text{etc.}$$

$$\gamma_{xy} = \frac{1}{G}\tau_{xy} \quad \text{etc.}$$

where:  $\Delta T$  is temperature change.

For plane stress with the  $z$  face unstressed and  $\Delta T = 0$ , the inverse relationship is

$$\sigma_{xx} = \frac{E}{(1-\nu^2)}(\varepsilon_{xx} + \nu\varepsilon_{yy}) \quad \text{etc.}$$

## 2.4. Complementary shear

From equilibrium of a small element,

$$\tau_{xy} = \tau_{yx} \quad \text{etc.}$$

From its definition,

$$\gamma_{xy} = \gamma_{yx} \quad \text{etc.}$$

## 2.5. Planar transformation equations for stress

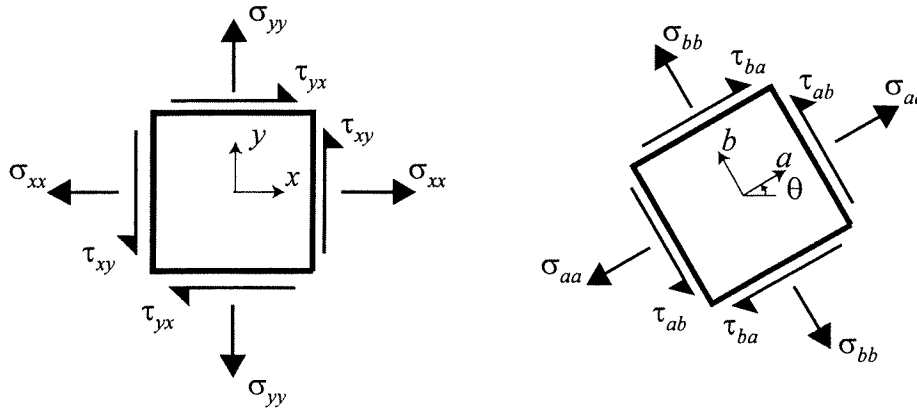

From equilibrium of an elementary triangle,

$$\sigma_{aa} = \sigma_{xx} \cos^2 \theta + \sigma_{yy} \sin^2 \theta + 2\tau_{xy} \sin \theta \cos \theta$$

$$\tau_{ab} = -\sigma_{xx} \sin \theta \cos \theta + \sigma_{yy} \sin \theta \cos \theta + \tau_{xy} (\cos^2 \theta - \sin^2 \theta)$$

## 2.6. Mohr's circle of stress

A plot of normal stress against shear stress on a face for varying  $\theta$  gives a circle, provided a special sign convention is used:

*For Mohr's circle, shear stress is plotted positive when it is clockwise*

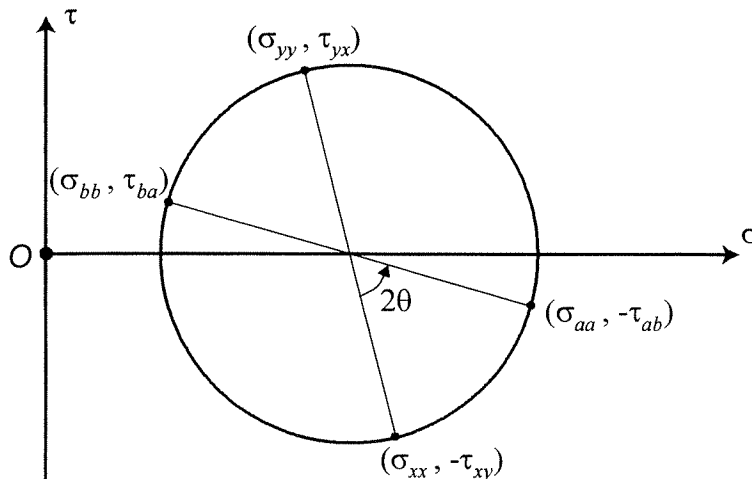

The stresses on perpendicular faces,  $(\sigma_{xx}, -\tau_{xy})$  and  $(\sigma_{yy}, \tau_{yx})$ , plot at the opposite ends of a diameter. If new faces are considered at angle  $\theta$  (see Section 2.5), the stresses on the new faces can be obtained by rotating the diameter of Mohr's circle by  $2\theta$  in the same direction.

## 2.7. Planar transformation equations for strain

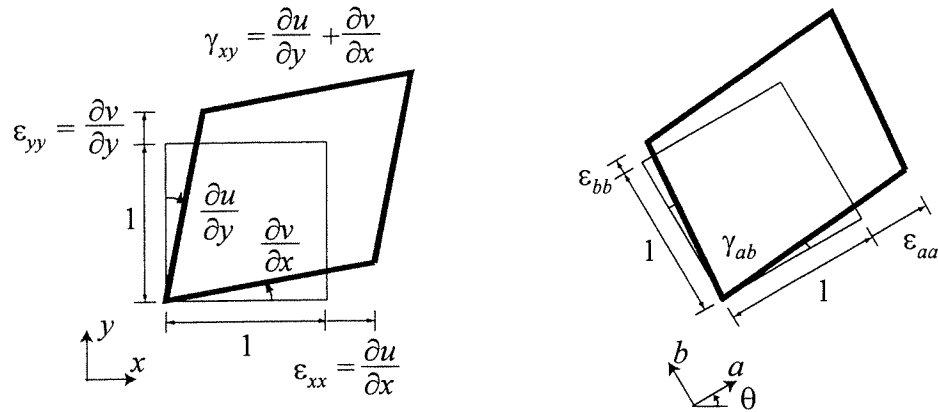

By geometry,

$$\epsilon_{aa} = \epsilon_{xx} \cos^2 \theta + \epsilon_{yy} \sin^2 \theta + \gamma_{xy} \sin \theta \cos \theta$$

$$\gamma_{ab} = -2\epsilon_{xx} \sin \theta \cos \theta + 2\epsilon_{yy} \sin \theta \cos \theta + \gamma_{xy} (\cos^2 \theta - \sin^2 \theta)$$

## 2.8. Mohr's circle of strain

A plot of normal strain against *half* shear strain for varying  $\theta$  gives a circle, if the sign convention for shear strains is the same as for corresponding shear stresses:

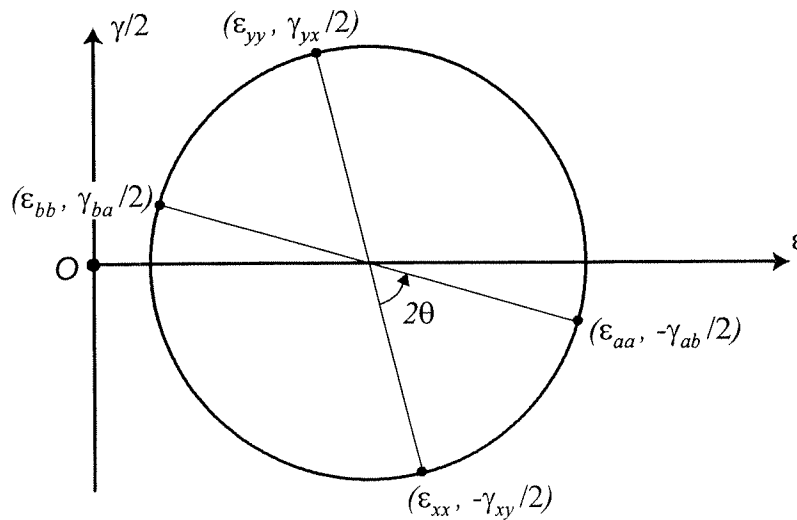

The strains in perpendicular directions,  $(\epsilon_{xx}, -\gamma_{xy}/2)$  and  $(\epsilon_{yy}, \gamma_{yx}/2)$ , plot at the opposite ends of a diameter. If new faces are considered at angle  $\theta$  (see Section 2.7), the strains in the new directions can be obtained by rotating the diameter of Mohr's circle by  $2\theta$  in the same direction.

## 2.9. Principal stresses in 3 dimensions

The principal stresses can be calculated as the eigenvalues of the stress matrix  $\underline{\sigma}$ , and the principal directions are the corresponding eigenvectors.

$$\underline{\sigma} = \begin{bmatrix} \sigma_{xx} & \tau_{xy} & \tau_{xz} \\ \tau_{yx} & \sigma_{yy} & \tau_{yz} \\ \tau_{zx} & \tau_{zy} & \sigma_{zz} \end{bmatrix}$$

## 2.10. Yield criteria for isotropic solids

Tresca's hypothesis:

$$\max[|\sigma_1 - \sigma_2|, |\sigma_2 - \sigma_3|, |\sigma_3 - \sigma_1|] = Y$$

Von Mises' hypothesis:

$$(\sigma_1 - \sigma_2)^2 + (\sigma_2 - \sigma_3)^2 + (\sigma_3 - \sigma_1)^2 = 2Y^2$$

where:  $Y$  is the current yield stress in simple tension

$\sigma_1, \sigma_2, \sigma_3$  are the principal stresses.

## 3. Beam behaviour

### 3.1. CUED sign convention

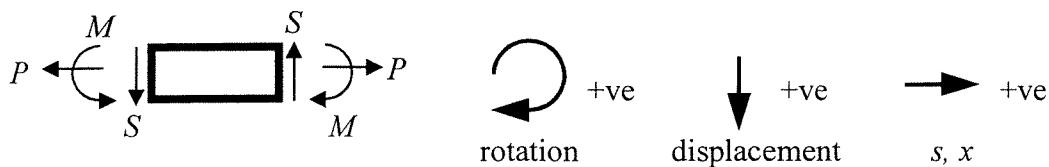

### 3.2. Compatibility

$$\kappa = \frac{d\psi}{ds} = \frac{1}{R}$$

where:  $\kappa$  is the curvature

$R$  is the local radius of curvature

$s$  is a distance along a beam

$\psi$  is the angle turned by tangent to the curve.

For a beam that has small transverse deflections  $v(x)$  from the  $x$  axis

$$\kappa \approx \frac{d^2v}{dx^2}$$

### 3.3. Equilibrium

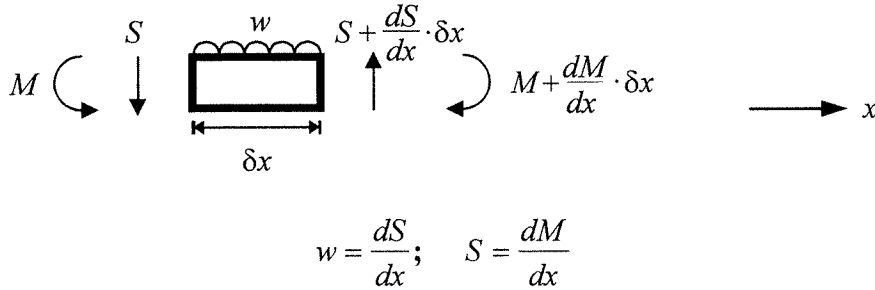

where:  $M$  is the bending moment  
 $S$  is the transverse shear force  
 $w$  is the transverse external load per unit length of beam.

### 3.4. Elastic bending formulae

#### 3.4.1. Longitudinal stresses

$$\frac{\sigma}{y} = \frac{M}{I} = E\Delta\kappa; \quad I = \int y^2 dA$$

$$M = Z_e \sigma_{max}$$

where:  $I$  is the second moment of area about a principal axis through the centroid (see also Mechanics Data Book)  
 $y$  is the distance from the centroidal axis  
 $\Delta\kappa$  is change of curvature from an initially unstressed configuration  
 $Z_e$  is the elastic section modulus  
 $\sigma_{max}$  is the stress at the outermost fibre.

#### 3.4.2. Transverse shear

If a free body is formed by cutting out part of the cross-section of a beam,

$$q = \frac{S}{I} \int_{A_c} y dA = \frac{S A_c \bar{y}}{I}$$

where:  $q$  is the total longitudinal shear force per unit longitudinal length of the beam (shear flow)  
 $A_c$  is the area of the cut off portion of the cross-section  
 $A_c \bar{y}$  is the first moment of area of the cut off portion about the centroidal axis.



At the cut, the shear stress is on average:

$$\tau = \frac{q}{a}$$

where:  $a$  is the length of the cut in the plane of the cross-section.

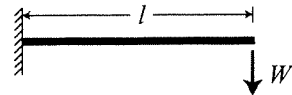
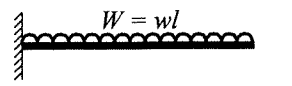

### 3.5. Formulae for elastic analysis

#### 3.5.1. Deflections for statically determinate structures

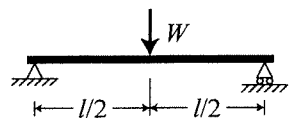
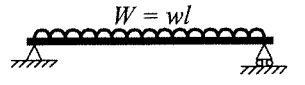
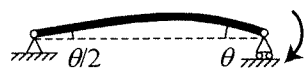
	end rotation	end deflection
	$\frac{Wl^2}{2EI}$	$\frac{Wl^3}{3EI}$
	$\frac{Wl^2}{6EI}$	$\frac{Wl^3}{8EI}$
	$\frac{Ml}{EI}$	$\frac{Ml^2}{2EI}$

	end rotation	central deflection
	$\frac{Wl^2}{16EI}$	$\frac{Wl^3}{48EI}$
	$\frac{Wl^2}{24EI}$	$\frac{5Wl^3}{384EI}$
	$\theta = \frac{Ml}{3EI}$	

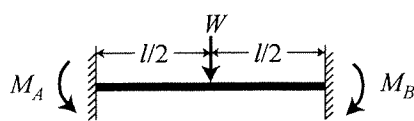
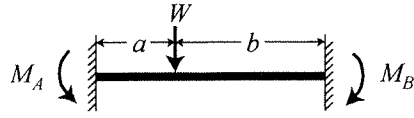
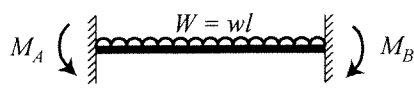
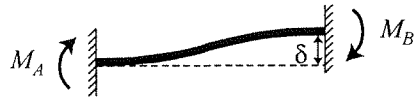
#### 3.5.2. Clamping moments for statically indeterminate structures

	$M_A$	$M_B$
	$\frac{Wl}{8}$	$\frac{Wl}{8}$
	$M_A$	$M_B$
	$\frac{Wb^2 a}{l^2}$	$\frac{Wa^2 b}{l^2}$
	$M_A$	$M_B$
	$\frac{Wl}{12}$	$\frac{Wl}{12}$
	$M_A$	$M_B$
	$\frac{6EI\delta}{l^2}$	$\frac{6EI\delta}{l^2}$
	$M_A$	$M_B$
	$\frac{2EI\theta}{l}$	$\frac{4EI\theta}{l}$



### 3.6. Plastic bending

For a beam fully yielded in bending, carrying no axial load, the neutral axis is at the equal-area axis, and

$$M_p = Z_p \sigma_y; \quad Z_p = \int |y| dA$$

where:  $M_p$  is the plastic moment  
 $Z_p$  is the plastic section modulus.

For cross-sections that can be easily split into regions that are fully yielded in *either* tension or compression,

$$Z_p = \sum A_i |y_i|$$

where:  $A_i$  is the area of a region  
 $y_i$  is the distance from the beam's equal-area axis to the centroid of the region.

### 3.7. Torsion formulae

#### 3.7.1. Circular shafts

For an elastic shaft,

$$\frac{\tau}{r} = \frac{T}{J}; \quad J = \int r^2 dA$$

$$T = GJ\phi$$

where:  $T$  is the applied torque  
 $\phi$  is the angle of twist per unit length  
 $r$  is the radius  
 $J$  is the polar second moment of area.

#### 3.7.2. Thin walled tubes (i.e. closed sections) of arbitrary cross-section

By equilibrium,

$$q = \frac{T}{2A_e}$$

By kinematics,

$$\phi = \frac{\oint \gamma ds}{2A_e}$$

For an elastic tube,

$$T = G \frac{4A_e^2}{\oint \frac{ds}{t}} \phi$$

where:  $q$  is the shear flow  $= \tau t$   
 $A_e$  is the area enclosed by the cross-section.

#### 3.7.3. Thin-walled open sections

$$T = G \sum \frac{1}{3} b t^3 \phi$$

where:  $b$  is the length, and  
 $t$  is the thickness of a region of the cross-section;  $t \ll b$ .

## 4. Euler buckling

For a perfect elastic pin-ended compression member (strut),

$$P_E = \frac{\pi^2 EI}{L^2}$$

where:  $P_E$  is the Euler buckling load  
 $EI$  is the bending stiffness of the strut about the appropriate axis  
 $L$  is the length of the strut

$$\sigma_E = \frac{P_E}{A} = \frac{\pi^2 E}{(L/k)^2}$$

where:  $\sigma_E$  is the Euler buckling stress  
 $A$  is the cross-sectional area of the strut  
 $k$  is the radius of gyration =  $\sqrt{I/A}$ .

## 5. Pin-jointed trusses – statical determinacy

For a pin-jointed assembly (Maxwell's rule, modified):

$$s - m = b + r - Dj$$

where: the pin jointed assembly is in  $D$  dimensions (2 or 3) with  $b$  bars and  $j$  joints  
 $r$  is the number of restraints on joint displacement  
 $s$  is the number of redundancies (states of self-stress)  
 $m$  is the number of independent mechanisms (degrees of freedom).

## 6. Equation of virtual work

For a pin-jointed framework, for *any* system of external forces  $W$  at the joints in equilibrium with bar tensions  $P$ , and any system of joint displacements  $\delta$  compatible with member extensions  $e$ ,

$$\underbrace{\sum_{\text{external forces}} W \cdot \delta}_{\text{equilibrium set}} = \underbrace{\sum_{\text{members}} P \cdot e}_{\text{compatible set}}$$

For other kinds of structure the equation is similar: external virtual work equals internal virtual work, provided that all the relevant contributing terms are included.

On L.H.S.: force·displacement, and/or couple·rotation, or pressure·swept volume, etc.

On R.H.S.: tension·extension, and/or bending moment·curvature  $\delta s$ , and/or  $\sigma \cdot \epsilon \delta V$ , or  $\tau \cdot \gamma \delta V$ , etc.

## 7. Soil mechanics

### 7.1. Definitions

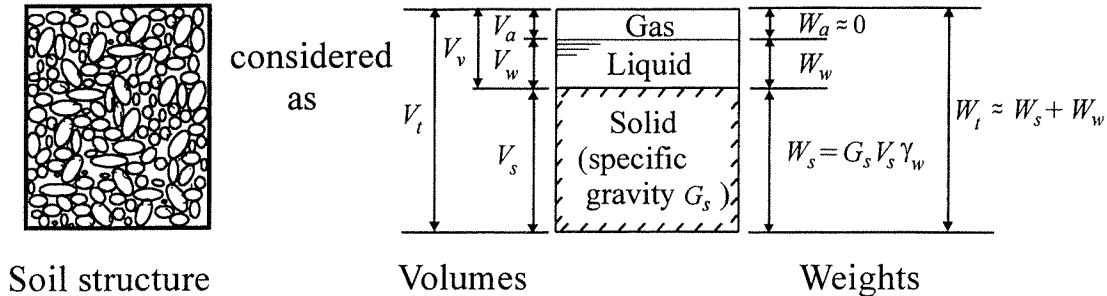

Voids ratio:  $e = \frac{V_v}{V_s}$  Unit weight of water  $\gamma_w = 9.81 \text{ kN/m}^3$

Water content:  $w = \frac{W_w}{W_s}$

Degree of saturation:  $S_r = \frac{V_w}{V_v} = w \frac{G_s}{e}$

Unit weight of soil:  $\gamma = \frac{W_t}{V_t} = \frac{\gamma_w (G_s + S_r e)}{(1 + e)}$

For sands:  $I_D = \frac{(e_{max} - e)}{(e_{max} - e_{min})}$

where:  $I_D$  is the relative density of packing  
 $e_{max}$  is the maximum voids ratio achievable in a quick tilt test and,  
 $e_{min}$  is the minimum voids ratio achievable by vibratory compaction.

### 7.2. Classification of particle sizes

Clay	smaller than 0.002 mm (two microns)	Gravel	between 2 and 60 mm
Silt	between 0.002 and 0.06 mm	Cobbles	between 60 and 200 mm
Sand	between 0.06 and 2 mm	Boulders	larger than 200 mm

$D$  equivalent diameter of soil particle  
 $D_{10}$ ,  $D_{60}$ , etc. particle size such that 10% (or 60 %) by weight of a soil sample is composed of finer grains.

### 7.3. Groundwater seepage

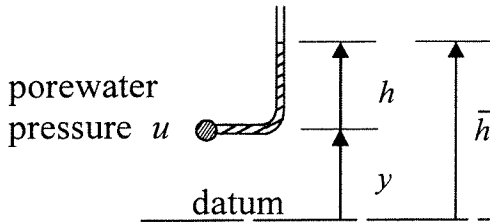

Head  $h = u / \gamma_w$   
 Potential  $\bar{h} = h + y$   
 Hydraulic gradient  $i = -\nabla \bar{h}$

Darcy's law for laminar flow:

$$v = ki$$

where:  $v$  is superficial seepage velocity  
 $k$  is coefficient of permeability.

Typical values:

clays :  $k$  between  $10^{-11}$  and  $10^{-9}$  m/s  
 1 micron  $< D_{10} < 10$  mm :  $k$  approximately  $0.01(D_{10} \text{ in mm})^2$  m/s  
 10 mm  $< D_{10}$  : non-laminar flow.

### 7.4. Stresses in soils

#### 7.4.1. Sign convention

**The normal sign convention for soil mechanics is to denote compressive stresses as positive. Hence in Section 7.4 only, compressive stresses are positive quantities.**

#### 7.4.2. Principle of effective stress (saturated soil)

Total stress components		Effective stress components		Pore water pressure
$\sigma$	=	$\sigma'$	+	$u$
$\tau$	=	$\tau'$	+	$0$

(The dash on the effective shear stress components is often omitted).

#### 7.4.3. Stresses in soil: Definitions

Mohr's circle of stress:

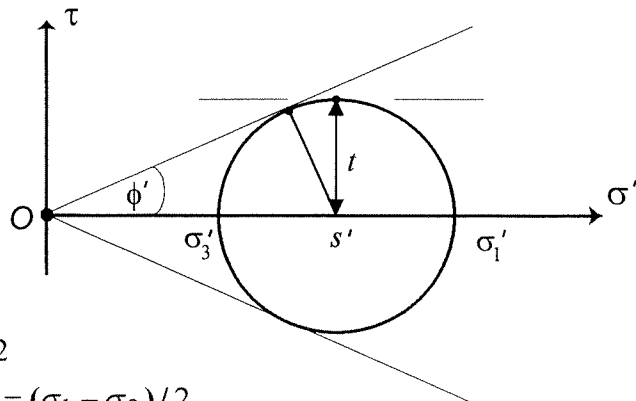

mean effective stress  $s' = (\sigma'_1 + \sigma'_3) / 2$   
 mobilised shear strength  $t = (\sigma'_1 - \sigma'_3) / 2 = (\sigma_1 - \sigma_3) / 2$   
 mobilised angle of shearing  $\phi' = \sin^{-1}(t / s')$

### 7.5. Strength of soil: Cohesion hypothesis (Tresca)

In constant-volume tests on clay, failure occurs when  $t$  reaches  $t_{max}=c_u$  where:  $c_u$  is the undrained *shear strength*, which depends primarily on the voids ratio  $e$ .

### 7.6. Friction hypothesis (Coulomb)

In any shear test on soil, failure occurs when  $\phi'$  reaches  $\phi'_{max}$ , and

$$\phi'_{max} = \phi'_{critical} + \phi'_{dilatancy}$$

where:  $\phi'_{critical}$  is the ultimate angle of shearing resistance of a random aggregate deforming at constant volume, and  $\phi'_{dilatancy} \rightarrow 0$  for either  $I_D \rightarrow 0$ , or  $s' \rightarrow$  large.

Typical properties for a quartz sand;

$$\phi'_{critical}=33^\circ, \quad \phi'_{max}=53^\circ \quad (I_D=1, s' < 150 \text{ kN/m}^2).$$

## 8. Typical properties and forms of structural materials

The following selection of mechanical properties and sections is for teaching purposes only. When designing any structure, reference should be made to the relevant British Standard.

### 8.1. Mechanical properties of steel and aluminium

	Structural Steel		Aluminium	
	Grade 43 (BS EN - S275)	Grade 50 (BS EN - S355)	Alloy 6082- T6	Alloy 5251 - H24
Yield stress $\sigma_y$ (MPa)	245*	325*	255*	185*
Typical form	Hot-rolled sections and plate		Extruded sections, plate	Plate, sheet

\* Typical values

### 8.2. Mechanical properties of glass fibre reinforced plastic (GFRP)

Properties of GFRP can vary widely. One particular example is as follows:

Glass fibre in Polyester Matrix Fibreforce Composites Ltd - Force 800 – Mat/roving			
Longitudinal Tensile Properties		In-plane Shear Modulus	Density
Modulus	Breaking Stress		
$E$ (GPa)	$\sigma_t$ (MPa)	$G$ (GPa)	$\rho$ (kg/m <sup>3</sup> )
17.2	207	2.9	1800

### 8.3. Structural steel sections (hot-rolled)

Pages 12-19 are reproduced and adapted from *Steelwork Design Guide to BS5950: Part 1: 1990 – Volume 1, Section Properties and Member Capacities (5th Edition)*, by kind permission of the Director, The Steel Construction Institute, Ascot, Berkshire.

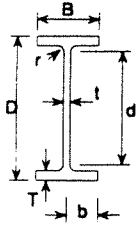

#### UNIVERSAL BEAMS



Section Designation	Mass Per Metre kg/m	Depth Of Section D mm	Width Of Section B mm	Thickness		Second Moment Of Area		Radius Of Gyration		Elastic Modulus		Plastic Modulus		Torsional Constant J cm <sup>4</sup>	Area Of Section A cm <sup>2</sup>
				Web t mm	Flange T mm	Axis x-x cm <sup>4</sup>	Axis y-y cm <sup>4</sup>	Axis x-x cm	Axis y-y cm	Axis x-x cm <sup>3</sup>	Axis y-y cm <sup>3</sup>	Axis x-x cm <sup>3</sup>	Axis y-y cm <sup>3</sup>		
914x419x388	388.0	921.0	420.5	21.4	36.6	719600	45440	38.2	9.59	15630	2161	17670	3341	1734	494
914x419x343	343.3	911.8	418.5	19.4	32.0	625800	39160	37.8	9.46	13730	1871	15480	2890	1193	437
914x305x289	289.1	926.8	307.7	19.5	32.0	504200	15600	37.0	6.51	10880	1014	12570	1601	926	368
914x305x253	253.4	918.4	305.5	17.3	27.9	436300	13300	36.8	6.42	9501	871	10940	1371	626	323
914x305x224	224.2	910.4	304.1	15.9	23.9	376400	11240	36.3	6.27	8269	739	9535	1163	422	286
914x305x201	200.9	903.0	303.3	15.1	20.2	325300	9423	35.7	6.07	7204	621	8351	982	291	256
838x292x226	226.5	850.9	293.8	16.1	26.8	339700	11360	34.3	6.27	7985	773	9155	1212	514	289
838x292x194	193.8	840.7	292.4	14.7	21.7	279200	9066	33.6	6.06	6641	620	7640	974	306	247
838x292x178	175.9	834.9	291.7	14.0	18.8	246000	7799	33.1	5.90	5893	535	6808	842	221	224
762x267x197	198.8	769.8	268.0	15.6	25.4	240000	8175	30.9	5.71	6234	610	7167	959	404	251
762x267x173	173.0	762.2	266.7	14.3	21.6	205300	6850	30.5	5.58	5387	514	6198	807	267	220
762x267x147	148.9	754.0	265.2	12.8	17.5	168500	5455	30.0	5.40	4470	411	5156	647	159	187
762x267x134	133.9	750.0	264.4	12.0	15.5	150700	4788	29.7	5.30	4018	362	4644	570	119	171
686x254x170	170.2	692.9	255.8	14.5	23.7	170300	6630	28.0	5.53	4916	518	5631	811	308	217
686x254x152	152.4	687.5	254.5	13.2	21.0	150400	5784	27.8	5.46	4374	455	5000	710	220	194
686x254x140	140.1	683.5	253.7	12.4	19.0	136300	5183	27.6	5.39	3987	409	4558	638	169	178
686x254x125	125.2	677.9	253.0	11.7	16.2	118000	4383	27.2	5.24	3481	346	3994	542	116	159
610x305x238	238.1	635.8	311.4	18.4	31.4	209500	15840	26.3	7.23	6589	1017	7486	1574	785	303
610x305x179	179.0	620.2	307.1	14.1	23.6	153000	11410	25.9	7.07	4935	743	5547	1144	340	228
610x305x149	149.2	612.4	304.8	11.8	19.7	125900	9308	25.7	7.00	4111	611	4594	937	200	190
610x229x140	139.9	617.2	230.2	13.1	22.1	111800	4505	25.0	5.03	3622	391	4142	611	216	178
610x229x125	125.1	612.2	229.0	11.9	19.6	98610	3932	24.9	4.97	3221	343	3676	535	154	159
610x229x113	113.0	607.8	228.2	11.1	17.3	87320	3434	24.6	4.88	2874	301	3281	469	111	144
610x229x101	101.2	602.6	227.6	10.5	14.8	75780	2915	24.2	4.75	2515	256	2881	400	77.0	129
533x210x122	122.0	544.5	211.9	12.7	21.3	76040	3388	22.1	4.67	2793	320	3196	500	178	155
533x210x109	109.0	539.5	210.8	11.6	18.8	66820	2943	21.9	4.60	2477	279	2828	436	126	139
533x210x101	101.0	536.7	210.0	10.8	17.4	61520	2692	21.9	4.57	2292	256	2612	399	101	129
533x210x92	92.1	533.1	209.3	10.1	15.6	55230	2389	21.7	4.51	2072	228	2360	356	75.7	117
533x210x82	82.2	528.3	208.8	9.6	13.2	47540	2007	21.3	4.38	1800	192	2059	300	51.5	105
457x191x98	98.3	467.2	192.8	11.4	19.6	45730	2347	19.1	4.33	1957	243	2232	379	121	125
457x191x89	89.3	463.4	191.9	10.5	17.7	41020	2089	19.0	4.29	1770	218	2014	338	90.7	114
457x191x82	82.0	460.0	191.3	9.9	16.0	37050	1871	18.8	4.23	1611	196	1831	304	69.2	104
457x191x74	74.3	457.0	190.4	9.0	14.5	33320	1671	18.8	4.20	1458	176	1653	272	51.8	94.6
457x191x67	67.1	453.4	189.9	8.5	12.7	29380	1452	18.5	4.12	1296	153	1471	237	37.1	85.5
457x152x82	82.1	465.8	155.3	10.5	18.9	36590	1185	18.7	3.37	1571	153	1811	240	89.2	105
457x152x74	74.2	462.0	154.4	9.6	17.0	32670	1047	18.6	3.33	1414	136	1627	213	65.9	94.5
457x152x67	67.2	458.0	153.8	9.0	15.0	28930	913	18.4	3.27	1263	119	1453	187	47.7	85.6
457x152x60	59.8	454.6	152.9	8.1	13.3	25500	795	18.3	3.23	1122	104	1287	163	33.8	76.2
457x152x52	52.3	449.8	152.4	7.6	10.9	21370	645	17.9	3.11	950	84.6	1096	133	21.4	66.6

Note: In the Section Tables in 8.3 and 8.4, the torsional constant  $J$  is defined by the equation  $J = T/(G\phi)$  and will not be the polar second moment of area (unless the cross-section is circular).

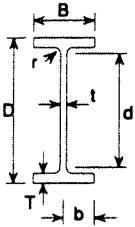

## UNIVERSAL BEAMS

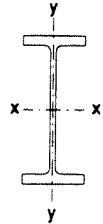

Section Designation	Mass Per Metre kg/m	Depth Of Section D mm	Width Of Section B mm	Thickness		Second Moment Of Area		Radius Of Gyration		Elastic Modulus		Plastic Modulus		Torsional Constant J cm <sup>4</sup>	Area Of Section A cm <sup>2</sup>
				Web t mm	Flange T mm	Axis x-x cm <sup>4</sup>	Axis y-y cm <sup>4</sup>	Axis x-x cm	Axis y-y cm	Axis x-x cm <sup>3</sup>	Axis y-y cm <sup>3</sup>	Axis x-x cm <sup>3</sup>	Axis y-y cm <sup>3</sup>		
406x178x74	74.2	412.8	179.5	9.5	16.0	27310	1545	17.0	4.04	1323	172	1501	267	62.8	94.5
406x178x67	67.1	409.4	178.8	8.8	14.3	24330	1365	16.9	3.99	1189	153	1346	237	46.1	85.5
406x178x60	60.1	406.4	177.9	7.9	12.8	21600	1203	16.8	3.97	1063	135	1199	209	33.3	76.5
406x178x54	54.1	402.6	177.7	7.7	10.9	18720	1021	16.5	3.85	930	115	1055	178	23.1	69.0
406x140x46	46.0	403.2	142.2	6.8	11.2	15690	538	16.4	3.03	778	75.7	888	118	19.0	58.6
406x140x39	39.0	398.0	141.8	6.4	8.6	12510	410	15.9	2.87	629	57.8	724	90.8	10.7	49.7
356x171x67	67.1	363.4	173.2	9.1	15.7	19460	1362	15.1	3.99	1071	157	1211	243	55.7	85.5
356x171x57	57.0	358.0	172.2	8.1	13.0	16040	1108	14.9	3.91	896	129	1010	199	33.4	72.6
356x171x51	51.0	355.0	171.5	7.4	11.5	14140	968	14.8	3.86	796	113	896	174	23.8	64.9
356x171x45	45.0	351.4	171.1	7.0	9.7	12070	811	14.5	3.76	687	94.8	775	147	15.8	57.3
356x127x39	39.1	353.4	126.0	6.6	10.7	10170	358	14.3	2.68	576	56.8	659	89.1	15.1	49.8
356x127x33	33.1	349.0	125.4	6.0	8.5	8249	280	14.0	2.58	473	44.7	543	70.3	8.79	42.1
305x165x54	54.0	310.4	166.9	7.9	13.7	11700	1063	13.0	3.93	754	127	846	196	34.8	68.8
305x165x46	46.1	306.6	165.7	6.7	11.8	9899	896	13.0	3.90	646	108	720	166	22.2	58.7
305x165x40	40.3	303.4	165.0	6.0	10.2	8503	764	12.9	3.86	560	92.6	623	142	14.7	51.3
305x127x48	48.1	311.0	125.3	9.0	14.0	9575	461	12.5	2.74	616	73.6	711	116	31.8	61.2
305x127x42	41.9	307.2	124.3	8.0	12.1	8196	389	12.4	2.70	534	62.6	614	98.4	21.1	53.4
305x127x37	37.0	304.4	123.4	7.1	10.7	7171	336	12.3	2.67	471	54.5	539	85.4	14.8	47.2
305x102x33	32.8	312.7	102.4	6.6	10.8	6501	194	12.5	2.15	416	37.9	481	60.0	12.2	41.8
305x102x28	28.2	308.7	101.8	6.0	8.8	5366	155	12.2	2.08	348	30.5	403	48.5	7.40	35.9
305x102x25	24.8	305.1	101.6	5.8	7.0	4455	123	11.9	1.97	292	24.2	342	38.8	4.77	31.6
254x146x43	43.0	259.6	147.3	7.2	12.7	6544	677	10.9	3.52	504	92.0	566	141	23.9	54.8
254x146x37	37.0	256.0	146.4	6.3	10.9	5537	571	10.8	3.48	433	78.0	483	119	15.3	47.2
254x146x31	31.1	251.4	146.1	6.0	8.6	4413	448	10.5	3.36	351	61.3	393	94.1	8.55	39.7
254x102x28	28.3	260.4	102.2	6.3	10.0	4005	179	10.5	2.22	308	34.9	353	54.8	9.57	36.1
254x102x25	25.2	257.2	101.9	6.0	8.4	3415	149	10.3	2.15	266	29.2	306	46.0	6.42	32.0
254x102x22	22.0	254.0	101.6	5.7	6.8	2841	119	10.1	2.06	224	23.5	259	37.3	4.15	28.0
203x133x30	30.0	206.8	133.9	6.4	9.6	2896	385	8.71	3.17	280	57.5	314	88.2	10.3	38.2
203x133x25	25.1	203.2	133.2	5.7	7.8	2340	308	8.56	3.10	230	46.2	258	70.9	5.96	32.0
203x102x23	23.1	203.2	101.8	5.4	9.3	2105	164	8.46	2.36	207	32.2	234	49.8	7.02	29.4
178x102x19	19.0	177.8	101.2	4.8	7.9	1356	137	7.48	2.37	153	27.0	171	41.6	4.41	24.3
152x89x16	16.0	152.4	88.7	4.5	7.7	834	89.8	6.41	2.10	109	20.2	123	31.2	3.56	20.3
127x76x13	13.0	127.0	76.0	4.0	7.6	473	55.7	5.35	1.84	74.6	14.7	84.2	22.6	2.85	16.5

## UNIVERSAL COLUMNS

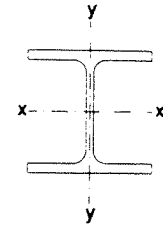
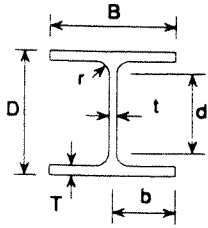

Section Designation	Mass Per Metre kg/m	Depth Of Section D mm	Width Of Section B mm	Thickness		Second Moment Of Area		Radius Of Gyration		Elastic Modulus		Plastic Modulus		Torsional Constant J cm <sup>4</sup>	Area Of Section A cm <sup>2</sup>
				Web t mm	Flange T mm	Axis x-x cm <sup>4</sup>	Axis y-y cm <sup>4</sup>	Axis x-x cm	Axis y-y cm	Axis x-x cm <sup>3</sup>	Axis y-y cm <sup>3</sup>	Axis x-x cm <sup>3</sup>	Axis y-y cm <sup>3</sup>		
356x406x634	633.9	474.8	424.0	47.6	77.0	274800	98130	18.4	11.0	11580	4629	14240	7108	13720	808
356x406x551	551.0	455.6	418.5	42.1	67.5	226900	82670	18.0	10.9	9962	3951	12080	6058	9240	702
356x406x467	467.0	436.6	412.2	35.8	58.0	183000	67830	17.5	10.7	8383	3291	10000	5034	5809	595
356x406x393	393.0	419.0	407.0	30.6	49.2	146600	55370	17.1	10.5	6998	2721	8222	4154	3545	501
356x406x340	339.9	406.4	403.0	26.6	42.9	122500	46850	16.8	10.4	6031	2325	6999	3544	2343	433
356x406x287	287.1	393.6	399.0	22.6	36.5	99880	38680	16.5	10.3	5075	1939	5812	2949	1441	366
356x406x235	235.1	381.0	394.8	18.4	30.2	79080	30990	16.3	10.2	4151	1570	4687	2383	812	299
356x368x202	201.9	374.6	374.7	16.5	27.0	66260	23690	16.1	9.60	3538	1264	3972	1920	558	257
356x368x177	177.0	368.2	372.6	14.4	23.8	57120	20530	15.9	9.54	3103	1102	3455	1671	381	226
356x368x153	152.9	362.0	370.5	12.3	20.7	48590	17550	15.8	9.49	2684	948	2965	1435	251	195
356x368x129	129.0	355.6	368.6	10.4	17.5	40250	14610	15.6	9.43	2264	793	2479	1199	153	164
305x305x283	282.9	365.3	322.2	26.8	44.1	78870	24630	14.8	8.27	4318	1529	5105	2342	2034	360
305x305x240	240.0	352.5	318.4	23.0	37.7	64200	20310	14.5	8.15	3643	1276	4247	1951	1271	306
305x305x198	198.1	339.9	314.5	19.1	31.4	50900	16300	14.2	8.04	2995	1037	3440	1581	734	252
305x305x158	158.1	327.1	311.2	15.8	25.0	38750	12570	13.9	7.90	2369	808	2680	1230	378	201
305x305x137	136.9	320.5	309.2	13.8	21.7	32810	10700	13.7	7.83	2048	692	2297	1053	249	174
305x305x118	117.9	314.5	307.4	12.0	18.7	27670	9059	13.6	7.77	1760	589	1958	895	161	150
305x305x97	96.9	307.9	305.3	9.9	15.4	22250	7308	13.4	7.69	1445	479	1592	726	91.2	123
254x254x167	167.1	289.1	265.2	19.2	31.7	30000	9870	11.9	6.81	2075	744	2424	1137	626	213
254x254x132	132.0	276.3	261.3	15.3	25.3	22530	7531	11.6	6.69	1631	576	1869	878	319	168
254x254x107	107.1	266.7	258.8	12.8	20.5	17510	5928	11.3	6.59	1313	458	1484	697	172	136
254x254x89	88.9	260.3	256.3	10.3	17.3	14270	4857	11.2	6.55	1096	379	1224	575	102	113
254x254x73	73.1	254.1	254.6	8.6	14.2	11410	3908	11.1	6.48	898	307	992	465	57.6	93.1
203x203x86	86.1	222.2	209.1	12.7	20.5	9449	3127	9.28	5.34	850	299	977	456	137	110
203x203x71	71.0	215.8	206.4	10.0	17.3	7618	2537	9.18	5.30	706	246	799	374	80.2	90.4
203x203x60	60.0	209.6	205.8	9.4	14.2	6125	2065	8.96	5.20	584	201	656	305	47.2	76.4
203x203x52	52.0	206.2	204.3	7.9	12.5	5259	1778	8.91	5.18	510	174	567	264	31.8	66.3
203x203x46	46.1	203.2	203.6	7.2	11.0	4568	1548	8.82	5.13	450	152	497	231	22.2	58.7
152x152x37	37.0	161.8	154.4	8.0	11.5	2210	708	6.85	3.87	273	91.5	309	140	19.2	47.1
152x152x30	30.0	157.6	152.9	6.5	9.4	1748	560	6.76	3.83	222	73.3	248	112	10.5	38.3
152x152x23	23.0	152.4	152.2	5.8	6.8	1250	400	6.54	3.70	164	52.6	182	80.2	4.63	29.2



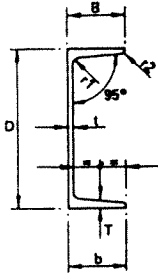

## CHANNELS

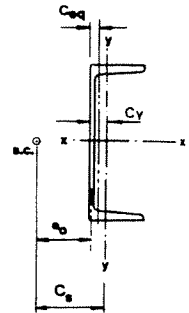

Designation		Depth Of Section D mm	Width Of Section B mm	Thickness		Second Moment Of Area		Radius Of Gyration		Elastic Modulus		Plastic Modulus		Torsional Constant J cm <sup>4</sup>	Area of Section A cm <sup>2</sup>
Nominal Size mm	Mass Per Metre kg			Web t mm	Flange T mm	Axis x-x cm <sup>4</sup>	Axis y-y cm <sup>4</sup>	Axis x-x cm	Axis y-y cm	Axis x-x cm <sup>3</sup>	Axis y-y cm <sup>3</sup>	Axis x-x cm <sup>3</sup>	Axis y-y cm <sup>3</sup>		
432x102	65.54	431.8	101.6	12.2	16.8	21370	627	16.0	2.74	990	79.9	1205	153	61.5	83.4
381x102	55.10	381.0	101.6	10.4	16.3	14870	579	14.6	2.87	781	75.7	931	144	46.4	70.1
305x102	46.18	304.8	101.6	10.2	14.8	8208	499	11.8	2.91	539	66.5	638	128	35.9	58.9
305x89	41.69	304.8	88.9	10.2	13.7	7078	326	11.5	2.47	464	48.6	559	92.9	28.1	53.3
254x89	35.74	254.0	88.9	9.1	13.6	4445	302	9.89	2.58	350	46.7	414	89.6	23.2	45.4
254x76	28.29	254.0	76.2	8.1	10.9	3355	162	9.67	2.12	264	28.1	316	53.9	12.3	35.9
229x89	32.76	228.6	88.9	8.6	13.3	3383	285	9.01	2.61	296	44.8	348	86.3	20.6	41.6
229x76	26.06	228.6	76.2	7.6	11.2	2615	159	8.87	2.19	229	28.3	271	54.5	11.6	33.2
203x89	29.78	203.2	88.9	8.1	12.9	2492	265	8.11	2.64	245	42.4	287	81.7	18.1	37.9
203x76	23.82	203.2	76.2	7.1	11.2	1955	152	8.02	2.24	192	27.7	226	53.5	10.6	30.4
178x89	26.81	177.8	88.9	7.6	12.3	1753	241	7.17	2.66	197	39.3	230	75.4	15.3	34.1
178x76	20.84	177.8	76.2	6.6	10.3	1338	134	7.10	2.25	151	24.8	176	48.1	8.26	26.6
152x89	23.84	152.4	88.9	7.1	11.6	1168	216	6.20	2.66	153	35.8	178	68.3	12.7	30.4
152x76	17.88	152.4	76.2	6.4	9.0	852	114	6.11	2.23	112	21.0	130	41.2	6.05	22.8
127x64	14.90	127.0	63.5	6.4	9.2	482	67.2	5.04	1.88	76.0	15.2	89.4	29.3	5.00	19.0
102x51	10.42◆	101.6	50.8	6.1	7.6	207	29.0	3.95	1.48	40.8	8.14	48.7	15.7	2.58	13.3
76x38	6.70◆	76.2	38.1	5.1	6.8	74.3	10.7	2.95	1.12	19.5	4.09	23.5	7.78	1.26	8.56

# CIRCULAR HOLLOW SECTIONS

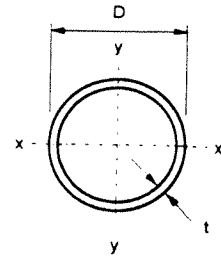

## DIMENSIONS AND PROPERTIES

Designation		Mass per Metre kg	Area of Section A cm <sup>2</sup>	Ratio for Local Buckling D/t	Second Moment of Area I cm <sup>4</sup>	Radius of Gyration r cm	Elastic Modulus Z cm <sup>3</sup>	Plastic Modulus S cm <sup>3</sup>	Torsional Constants		Surface Area per Metre m <sup>2</sup>
Outside Diameter D mm	Thickness t mm								J cm <sup>4</sup>	C cm <sup>3</sup>	
21.3	3.2Δ	1.43	1.82	6.66	0.768	0.650	0.722	1.06	1.54	1.44	0.0669
26.9	3.2Δ	1.87	2.38	8.41	1.70	0.846	1.27	1.81	3.41	2.53	0.0845
33.7	2.6Δ	1.99	2.54	13.0	3.09	1.10	1.84	2.52	6.19	3.67	0.106
	3.2Δ	2.41	3.07	10.5	3.60	1.08	2.14	2.99	7.21	4.28	0.106
	4.0Δ	2.93	3.73	8.43	4.19	1.06	2.49	3.55	8.38	4.97	0.106
42.4	2.6Δ	2.55	3.25	16.3	6.46	1.41	3.05	4.12	12.9	6.10	0.133
	3.2Δ	3.09	3.94	13.3	7.62	1.39	3.59	4.93	15.2	7.19	0.133
	4.0Δ	3.79	4.83	10.6	8.99	1.36	4.24	5.92	18.0	8.48	0.133
48.3	3.2	3.56	4.53	15.1	11.6	1.60	4.80	6.52	23.2	9.59	0.152
	4.0	4.37	5.57	12.1	13.8	1.57	5.70	7.87	27.5	11.4	0.152
	5.0	5.34	6.80	9.66	16.2	1.54	6.69	9.42	32.3	13.4	0.152
60.3	3.2	4.51	5.74	18.8	23.5	2.02	7.78	10.4	46.9	15.6	0.189
	4.0	5.55	7.07	15.1	28.2	2.00	9.34	12.7	56.3	18.7	0.189
	5.0	6.82	8.69	12.1	33.5	1.96	11.1	15.3	67.0	22.2	0.189
76.1	3.2	5.75	7.33	23.8	48.8	2.58	12.8	17.0	97.6	25.6	0.239
	4.0	7.11	9.06	19.0	59.1	2.55	15.5	20.8	118	31.0	0.239
	5.0	8.77	11.2	15.2	70.9	2.52	18.8	25.3	142	37.3	0.239
88.9	3.2	6.76	8.62	27.8	79.2	3.03	17.8	23.5	158	35.6	0.279
	4.0	8.38	10.7	22.2	96.3	3.00	21.7	28.9	193	43.3	0.279
	5.0	10.3	13.2	17.8	116	2.97	26.2	35.2	233	52.4	0.279
114.3	3.6	9.83	12.5	31.8	192	3.92	33.6	44.1	384	67.2	0.359
	5.0	13.5	17.2	22.9	257	3.87	45.0	59.8	514	89.9	0.359
	6.3	16.8	21.4	18.1	313	3.82	54.7	73.6	625	109	0.359
139.7	5.0	16.6	21.2	27.9	481	4.77	68.8	90.8	961	138	0.439
	6.3	20.7	26.4	22.2	589	4.72	84.3	112	1177	169	0.439
	8.0	26.0	33.1	17.5	720	4.66	103	139	1441	206	0.439
	10.0	32.0	40.7	14.0	862	4.60	123	169	1724	247	0.439
168.3	5.0	20.1	25.7	33.7	856	5.78	102	133	1712	203	0.529
	6.3	25.2	32.1	26.7	1053	5.73	125	165	2107	250	0.529
	8.0	31.6	40.3	21.0	1297	5.67	154	206	2595	308	0.529
	10.0	39.0	49.7	16.8	1564	5.61	186	251	3128	372	0.529
	12.5	48.0	61.2	13.5	1868	5.53	222	304	3737	444	0.529
193.7	5.0	23.3	29.6	38.7	1320	6.67	136	178	2640	273	0.609
	6.3	29.1	37.1	30.7	1630	6.63	168	221	3260	337	0.609
	8.0	36.6	46.7	24.2	2016	6.57	208	276	4031	416	0.609
	10.0	45.3	57.7	19.4	2442	6.50	252	338	4883	504	0.609
	12.5	55.9	71.2	15.5	2934	6.42	303	411	5869	606	0.609
	16.0♦	70.1	89.3	12.1	3554	6.31	367	507	7109	734	0.609

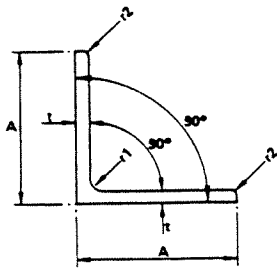

## EQUAL ANGLES

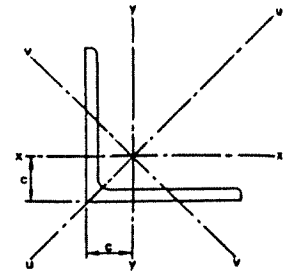

### DIMENSIONS AND PROPERTIES

Designation		Mass Per Metre kg	Radius		Area Of Section cm <sup>2</sup>	Distance Of Centre Of Gravity cx and cy cm	Second Moment Of Area			Radius Of Gyration			Elastic Modulus Axis x-x, y-y cm <sup>3</sup>
Size A A mm	Thickness t mm		Root r1 mm	Toe r2 mm			Axis x-x, y-y cm <sup>4</sup>	Axis u-u cm <sup>4</sup>	Axis v-v cm <sup>4</sup>	Axis x-x, y-y cm	Axis u-u cm	Axis v-v cm	
250x250	35	128	20.0	4.8	164	7.51	9305	14720	3886	7.54	9.49	4.88	532
	32	118	20.0	4.8	151	7.40	8650	13710	3592	7.58	9.54	4.89	491
	28	104	20.0	4.8	133	7.25	7741	12290	3154	7.63	9.61	4.90	436
	25	93.6	20.0	4.8	120	7.14	7030	11170	2890	7.67	9.67	4.92	394
200x200	24	71.1	18.0	4.8	90.8	5.85	3356	5322	1391	6.08	7.65	3.91	237
	20	59.9	18.0	4.8	76.6	5.70	2877	4569	1185	6.13	7.72	3.93	201
	18	54.2	18.0	4.8	69.4	5.62	2627	4174	1080	6.15	7.76	3.95	183
	16	48.5	18.0	4.8	62.0	5.54	2369	3765	973	6.18	7.79	3.96	164
150x150	18	40.1	16.0	4.8	51.2	4.38	1060	1680	440	4.55	5.73	2.93	99.8
	15	33.8	16.0	4.8	43.2	4.26	909	1442	375	4.59	5.78	2.95	84.6
	12	27.3	16.0	4.8	35.0	4.14	748	1187	308	4.62	5.82	2.97	68.9
	10	23.0	16.0	4.8	29.5	4.06	635	1008	262	4.64	5.85	2.99	58.0
120x120	15	26.6	13.0	4.8	34.0	3.52	448	710	186	3.63	4.57	2.34	52.8
	12	21.6	13.0	4.8	27.6	3.41	371	589	153	3.66	4.62	2.35	43.1
	10	18.2	13.0	4.8	23.3	3.32	316	502	130	3.69	4.65	2.37	36.4
	8	14.7	13.0	4.8	18.8	3.24	259	411	107	3.71	4.67	2.38	29.5
100x100	15	21.9	12.0	4.8	28.0	3.02	250	395	105	2.99	3.76	1.94	35.8
	12	17.8	12.0	4.8	22.8	2.91	208	330	86.5	3.02	3.81	1.95	29.4
	10+	15.0	12.0	4.8	19.2	2.83	178	283	73.7	3.05	3.84	1.96	24.8
	8	12.2	12.0	4.8	15.6	2.75	146	232	60.5	3.07	3.86	1.97	20.2
90x90	12	15.9	11.0	4.8	20.3	2.66	149	235	62.0	2.70	3.40	1.75	23.5
	10	13.4	11.0	4.8	17.2	2.58	128	202	52.9	2.73	3.43	1.76	19.9
	8	10.9	11.0	4.8	13.9	2.50	105	167	43.4	2.75	3.46	1.77	16.2
	7	9.61	11.0	4.8	12.3	2.46	93.2	148	38.6	2.76	3.47	1.77	14.3
	6	8.30	11.0	4.8	10.6	2.41	81.0	128	33.6	2.76	3.48	1.78	12.3
80x80	10	11.9	10.0	4.8	15.1	2.34	87.6	139	36.4	2.41	3.03	1.55	15.5
	8	9.63	10.0	4.8	12.3	2.26	72.4	115	29.9	2.43	3.06	1.56	12.6
	6	7.34	10.0	4.8	9.36	2.17	56.0	88.7	23.2	2.45	3.08	1.57	9.60
70x70	10	10.3	9.0	2.4	13.1	2.10	58.0	91.6	24.4	2.10	2.64	1.36	11.8
	8	8.36	9.0	2.4	10.7	2.02	48.3	76.5	20.1	2.12	2.67	1.37	9.70
	6	6.38	9.0	2.4	8.19	1.94	37.7	59.8	15.6	2.15	2.70	1.38	7.45
60x60	10	8.69	8.0	2.4	11.1	1.85	35.3	55.6	15.0	1.78	2.24	1.16	8.51
	8	7.09	8.0	2.4	9.07	1.78	29.6	46.7	12.4	1.80	2.27	1.17	7.00
	6	5.42	8.0	2.4	6.95	1.70	23.2	36.8	9.64	1.83	2.30	1.18	5.39
	5	4.57	8.0	2.4	5.86	1.65	19.8	31.4	8.23	1.84	2.31	1.18	4.56
50x50	8	5.82	7.0	2.4	7.44	1.53	16.5	25.9	6.96	1.49	1.87	0.968	4.74
	6	4.47	7.0	2.4	5.72	1.45	13.0	20.6	5.43	1.51	1.90	0.974	3.67
	5	3.77	7.0	2.4	4.83	1.41	11.1	17.7	4.63	1.52	1.91	0.979	3.11
	4	3.06	7.0	2.4	3.92	1.37	9.16	14.5	3.82	1.53	1.92	0.987	2.52
	3	2.33	7.0	2.4	2.99	1.32	7.06	11.1	2.97	1.54	1.93	0.996	1.92
45x45	6	4.00	7.0	2.4	5.12	1.33	9.30	14.7	3.90	1.35	1.69	0.872	2.93
	5	3.38	7.0	2.4	4.33	1.29	7.99	12.6	3.33	1.36	1.71	0.877	2.49
	4	2.74	7.0	2.4	3.52	1.24	6.58	10.4	2.75	1.37	1.72	0.883	2.02
	3	2.09	7.0	2.4	2.69	1.20	5.08	8.03	2.14	1.37	1.73	0.892	1.54
40x40	6	3.52	6.0	2.4	4.49	1.20	6.37	10.1	2.68	1.19	1.50	0.773	2.28
	5	2.97	6.0	2.4	3.80	1.17	5.48	8.68	2.29	1.20	1.51	0.776	1.93
	4	2.42	6.0	2.4	3.09	1.12	4.53	7.18	1.89	1.21	1.52	0.781	1.58
	3	1.84	6.0	2.4	2.36	1.08	3.51	5.55	1.47	1.22	1.53	0.788	1.20
30x30	5	2.18	5.0	2.4	2.78	0.919	2.17	3.42	0.919	0.883	1.11	0.575	1.04
	4	1.78	5.0	2.4	2.27	0.879	1.81	2.86	0.756	0.893	1.12	0.577	0.852
	3	1.36	5.0	2.4	1.74	0.836	1.41	2.23	0.588	0.900	1.13	0.581	0.652
25x25	5	1.77	3.5	2.4	2.25	0.796	1.19	1.87	0.515	0.728	0.912	0.478	0.701
	4	1.45	3.5	2.4	1.84	0.758	1.00	1.58	0.421	0.737	0.926	0.478	0.574
	3	1.11	3.5	2.4	1.41	0.718	0.784	1.24	0.325	0.745	0.939	0.480	0.440



### 8.5. Glass fibre reinforced plastic (GFRP) sections (pultrusions)\*

A wide variety of shapes is also possible with the pultrusion process and each GFRP manufacturer will produce a different standard product range. Typical examples:

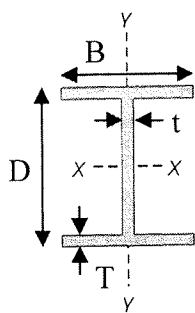

I- Beams

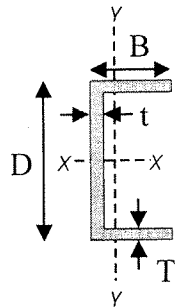

Channels

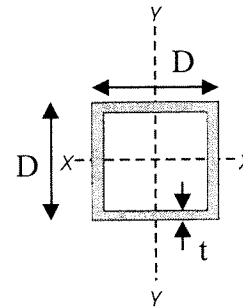

Square Hollow Sections

#### I-Beams

Section Designation	Depth D (mm)	Width B (mm)	Web t (mm)	Flange T (mm)	$I_{xx}$ (cm <sup>4</sup> )	$I_{yy}$ (cm <sup>4</sup> )	Area A (cm <sup>2</sup> )
53 × 50	53	50	7	7	40.8	14.7	9.73
102 × 51	102	51	6.35	6.35	186	14.2	12.1
150 × 150	150	150	10	10	1660	564	43.0
200 × 200	200	200	10	10	4100	1330	58.0

#### Channels

Section Designation	Depth D (mm)	Width B (mm)	Web t (mm)	Flange T (mm)	$I_{xx}$ (cm <sup>4</sup> )	$I_{yy}$ (cm <sup>4</sup> )	Area A (cm <sup>2</sup> )
50.8 × 25.4	50.8	25.4	3.2	3.2	11.6	1.82	3.05
73 × 25	73	25	5.0	5.0	39.4	2.76	5.65
100 × 40	100	40	5.0	5.0	121	11.9	8.50
200 × 50	200	50	10	10	1390	48.0	28.0
200 × 60	200	60	8.0	8.0	1300	68.9	24.3
500 × 60	500	60	7.0	7.0	11800	73.9	42.4

#### Square Hollow Sections

Designation		Area A (cm <sup>2</sup> )	$I_{xx} = I_{yy}$ (cm <sup>4</sup> )
Size D D (mm)	Thickness t (mm)		
31.8 × 31.8	3.0	3.46	4.83
44.0 × 44.0	6.0	9.12	22.5
51.0 × 51.0	3.2	6.12	23.4
100 × 100	4.0	15.3	236

\* The GFRP section details are based on information provided by Fibreforce Composites Ltd, Runcorn, Cheshire.

## Lipped Channel Sections

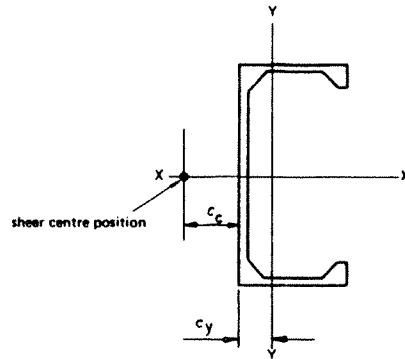
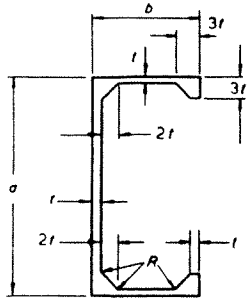

$$\begin{aligned}
 A &= 74.00t^2 \\
 R &= 2t \\
 e &= 32t \\
 b &= 16t \\
 c_x &= 0 \\
 c_y &= 5.36t \\
 c_c &= 6.91t \\
 I_x &= 12.371t^4 \\
 I_y &= 2.407t^4 \\
 r_x &= 12.93t \\
 r_y &= 5.70t \\
 Z_x &= 773t^3 \\
 Z_y &= 226t^3 \\
 J &= 41.29t^4
 \end{aligned}$$

\*Excludes small areas present at internal radii ( $4 \times 0.086t^2$ )

Size mm	Thickness mm	Mass/unit length kg/m	Area of section $\text{mm}^2 \times 10^2$	Centroid		Second moments of area $\text{mm}^4 \times 10^4$		Radii of gyration mm		Moduli of section $\text{mm}^3 \times 10^3$		Torsion constant $\text{mm}^4 \times 10^3$	Shear centre from back of section mm
				$c_x$	$c_y$	$I_x$	$I_y$	$r_x$	$r_y$	$Z_x$	$Z_y$		
$a \times b$	$t$	$w$	$A$	$c_x$	$c_y$	$I_x$	$I_y$	$r_x$	$r_y$	$Z_x$	$Z_y$	$J$	$c_c$
80 x 40	2.5	1.25	4.62	0	13.4	48.3	9.40	32.3	14.2	12.1	3.53	1.61	17.3
100 x 50	3.13	1.96	7.23	0	16.8	118	23.0	40.4	17.8	23.8	6.90	3.94	21.6
120 x 60	3.75	2.82	10.4	0	20.1	245	47.6	48.5	21.4	40.8	11.9	8.16	26.9
140 x 70	4.38	3.84	14.2	0	23.5	453	88.2	56.6	24.9	64.8	18.9	15.1	30.2

## Equal Bulb Angle Sections

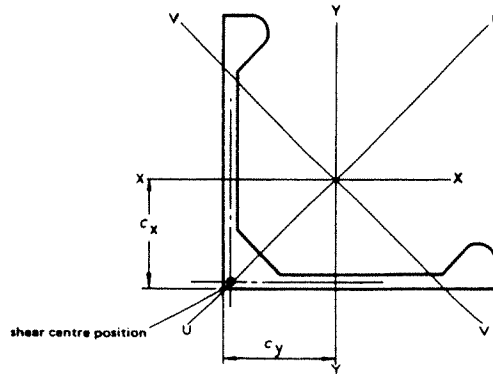
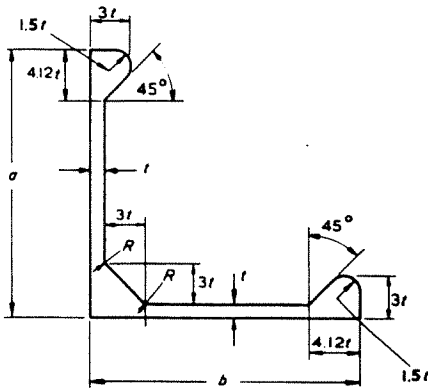

U-U and V-V are principal axes

$$\begin{aligned}
 A &= 54.92t^2 & c_x &= 6.07t & r_x &= 6.89t & Z_U &= 286t^3 \\
 R &= 2t & c_y &= 6.07t & r_y &= 6.89t & Z_V &= 138t^3 \\
 a = b &= 20t & I_x &= 2605t^4 & r_u &= 8.57t & \alpha &= 45^\circ \\
 & & I_y &= 2605t^4 & r_v &= 4.64t & \tan \alpha &= 1 \\
 & & I_u &= 4030t^4 & Z_x &= 187t^3 & J &= 51.32t^4 \\
 & & I_v &= 1180t^4 & Z_y &= 187t^3 & &
 \end{aligned}$$

Size mm	Thickness mm	Mass/unit length kg/m	Area of section $\text{mm}^2 \times 10^2$	Centroid mm	Second moments of area $\text{mm}^4 \times 10^4$				Radii of gyration mm			Moduli of section $\text{mm}^3 \times 10^3$			Torsion constant $\text{mm}^4 \times 10^4$
					$c_x$ and $c_y$	$I_x$ and $I_y$	$I_u$	$I_v$	$r_x$ and $r_y$	$r_u$	$r_v$	$Z_x$ and $Z_y$	$Z_u$	$Z_v$	
$a \times b$	$t$	$w$	$A$	$c_x$ and $c_y$	$I_x$ and $I_y$	$I_u$	$I_v$	$r_x$ and $r_y$	$r_u$	$r_v$	$Z_x$ and $Z_y$	$Z_u$	$Z_v$	$J$	
50 x 50	2.5	0.930	3.43	15.2	10.2	15.7	4.61	17.2	21.4	11.6	2.92	4.46	2.16	0.200	
60 x 60	3	1.34	4.94	18.2	21.1	32.6	9.56	20.7	25.7	13.9	5.06	7.70	3.73	0.416	
80 x 80	4	2.38	8.79	24.3	66.7	103	30.2	27.6	34.3	18.6	12.0	18.2	8.82	1.31	
100 x 100	5	3.72	13.7	30.3	163	252	73.8	34.4	42.8	23.2	23.4	35.6	17.2	3.21	
120 x 120	6	5.36	19.8	36.4	338	522	153	41.3	51.4	27.8	40.4	61.6	29.8	6.65	

[1] Dwight, J.B. (1999), *Aluminium Design and Construction*, E&FN Spon, London and New York.

[2] British Standards Institute, (1977), *Specification for Aluminium Alloy Sections for Structural Purposes, BS1161:1977*, British Standards Institute, UK.

### 8.4. Aluminium sections (extrusions)

When designing with aluminium there is limited use of standard sections since the extrusion process is very versatile and it is possible to achieve a wide variety of section shapes [1]:

Standard profiles are covered by British Standard BS1161 [2].

#### I-Beams

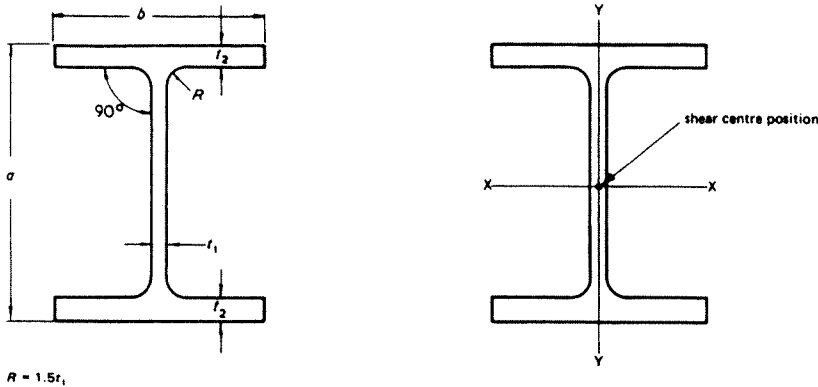

$R = 1.5r_1$

Size mm	Thickness mm		Mass/unit length kg/m	Area of section mm <sup>2</sup> x 10 <sup>2</sup>	Centroid mm		Second moments of area mm <sup>4</sup> x 10 <sup>4</sup>		Radii of gyration mm		Moduli of section mm <sup>3</sup> x 10 <sup>3</sup>		Torsion constant mm <sup>4</sup> x 10 <sup>4</sup>
	Web t <sub>1</sub>	Flange t <sub>2</sub>			c <sub>x</sub> and c <sub>y</sub>	I <sub>x</sub>	I <sub>y</sub>	r <sub>x</sub>	r <sub>y</sub>	Z <sub>x</sub>	Z <sub>y</sub>		
a x b	t <sub>1</sub>	t <sub>2</sub>	w	A	c <sub>x</sub> and c <sub>y</sub>	I <sub>x</sub>	I <sub>y</sub>	r <sub>x</sub>	r <sub>y</sub>	Z <sub>x</sub>	Z <sub>y</sub>	J	
60 x 30	4	6	1.59	5.83	0	31.6	2.76	23.3	6.89	10.5	1.84	0.753	
80 x 40	5	7	2.54	9.38	0	91.6	7.83	31.2	9.02	22.9	3.82	1.69	
100 x 50	6	8	3.72	13.7	0	210	17.0	39.2	11.1	42.1	6.80	3.30	
120 x 60	6	9	4.77	17.6	0	403	32.8	47.8	13.6	67.2	10.9	4.78	
140 x 70	7	10	6.33	23.4	0	725	57.9	55.7	15.7	104	16.5	8.00	
160 x 80	7	11	7.64	28.2	0	1170	94.6	64.5	18.3	147	23.7	10.8	

#### Channel Sections

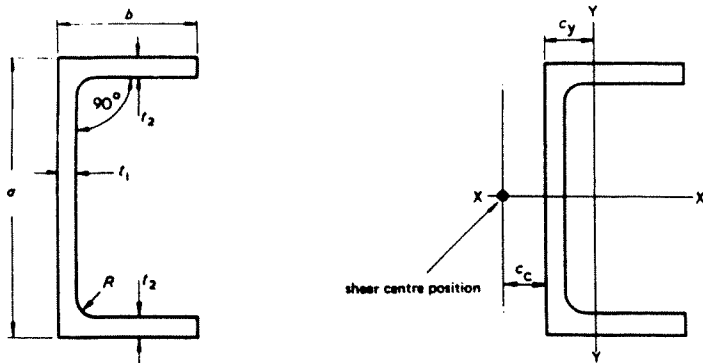

$R = 1.5r_1$

Size mm	Thickness mm		Mass/unit length kg/m	Area of section mm <sup>2</sup> x 10 <sup>2</sup>	Centroid mm		Second moments of area mm <sup>4</sup> x 10 <sup>4</sup>		Radii of gyration mm		Moduli of section mm <sup>3</sup> x 10 <sup>3</sup>		Torsion constant mm <sup>4</sup> x 10 <sup>4</sup>	Shear centre from back of section mm
	Web t <sub>1</sub>	Flange t <sub>2</sub>			c <sub>x</sub>	c <sub>y</sub>	I <sub>x</sub>	I <sub>y</sub>	r <sub>x</sub>	r <sub>y</sub>	Z <sub>x</sub>	Z <sub>y</sub>		
a x b	t <sub>1</sub>	t <sub>2</sub>	w	A	c <sub>x</sub>	c <sub>y</sub>	I <sub>x</sub>	I <sub>y</sub>	r <sub>x</sub>	r <sub>y</sub>	Z <sub>x</sub>	Z <sub>y</sub>	J	c <sub>c</sub>
60 x 30	5	6	1.69	6.24	0	9.87	32.2	5.03	22.7	8.98	10.7	2.50	0.890	11.7
80 x 35	5	7	2.29	8.44	0	11.3	79.8	9.57	30.6	10.6	20.0	4.04	1.12	13.8
100 x 40	6	8	3.20	11.8	0	12.4	171	16.9	38.1	11.9	34.2	6.12	2.07	15.2
120 x 50	6	9	4.19	15.5	0	15.9	339	36.8	48.8	15.4	56.5	10.8	3.22	19.7
140 x 60	7	10	5.66	20.9	0	18.9	625	71.5	54.7	18.5	89.2	17.4	5.51	23.6
160 x 70	7	10	6.58	24.3	0	21.8	970	116	63.2	21.8	121	24.0	6.41	27.6
180 x 75	8	11	8.06	29.8	0	22.7	1480	159	70.5	23.1	164	30.5	9.63	29.0
200 x 80	8	12	9.19	33.9	0	24.5	2110	210	78.8	24.9	211	37.8	12.4	31.3
240 x 100	9	13	12.5	46.0	0	30.3	4170	450	95.2	31.2	345	64.6	20.2	39.2

## RECTANGULAR HOLLOW SECTIONS

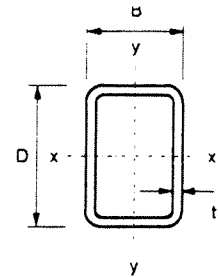

### DIMENSIONS AND PROPERTIES

Designation		Mass per Metre kg	Area of Section A cm <sup>2</sup>	Ratios for Local Buckling		Second Moment of Area		Radius of Gyration		Elastic Modulus		Plastic Modulus		Torsional Constants		Surface Area per Metre m <sup>2</sup>
Size D B mm	Thickness t mm			(1) d/t	(1) b/t	Axis x-x cm <sup>4</sup>	Axis y-y cm <sup>4</sup>	Axis x-x cm	Axis y-y cm	Axis x-x cm <sup>3</sup>	Axis y-y cm <sup>3</sup>	Axis x-x cm <sup>3</sup>	Axis y-y cm <sup>3</sup>	J cm <sup>4</sup>	C cm <sup>3</sup>	
50x30	2.5	2.89	3.68	17.0	9.00	11.8	5.22	1.79	1.19	4.73	3.48	5.92	4.11	11.7	5.73	0.154
	3.0	3.41	4.34	13.7	7.00	13.6	5.94	1.77	1.17	5.43	3.96	6.88	4.76	13.5	6.51	0.152
	3.2	3.61	4.60	12.6	6.38	14.2	6.20	1.76	1.16	5.68	4.13	7.25	5.00	14.2	6.80	0.152
	4.0	4.39	5.59	9.50	4.50	16.5	7.08	1.72	1.13	6.60	4.72	8.59	5.88	16.6	7.77	0.150
	5.0	5.28	6.73	7.00	3.00	18.7	7.89	1.67	1.08	7.49	5.26	10.0	6.80	19.0	8.67	0.147
60x40	2.5	3.68	4.68	21.0	13.0	22.8	12.1	2.21	1.60	7.61	6.03	9.32	7.02	25.1	9.73	0.194
	3.0	4.35	5.54	17.0	10.3	26.5	13.9	2.18	1.58	8.82	6.95	10.9	8.19	29.2	11.2	0.192
	3.2	4.62	5.88	15.8	9.50	27.8	14.6	2.18	1.57	9.27	7.29	11.5	8.64	30.8	11.7	0.192
	4.0	5.64	7.19	12.0	7.00	32.8	17.0	2.14	1.54	10.9	8.52	13.8	10.3	36.7	13.7	0.190
	5.0	6.85	8.73	9.00	5.00	38.1	19.5	2.09	1.50	12.7	9.77	16.4	12.2	43.0	15.7	0.187
6.3	8.31	10.6	6.52	3.35	43.4	21.9	2.02	1.44	14.5	11.0	19.2	14.2	49.5	17.6	0.184	
80x40	3.0	5.29	6.74	23.7	10.3	54.2	18.0	2.84	1.63	13.6	9.00	17.1	10.4	43.8	15.3	0.232
	3.2	5.62	7.16	22.0	9.50	57.2	18.9	2.83	1.63	14.3	9.46	18.0	11.0	46.2	16.1	0.232
	4.0	6.90	8.79	17.0	7.00	68.2	22.2	2.79	1.59	17.1	11.1	21.8	13.2	55.2	18.9	0.230
	5.0	8.42	10.7	13.0	5.00	80.3	25.7	2.74	1.55	20.1	12.9	26.1	15.7	65.1	21.9	0.227
	6.3	10.3	13.1	9.70	3.35	93.3	29.2	2.67	1.49	23.3	14.6	31.1	18.4	75.6	24.8	0.224
8.0	12.5	16.0	7.00	2.00	106	32.1	2.58	1.42	26.5	16.1	36.5	21.2	85.8	27.4	0.219	
90x50	3.0	6.24	7.94	27.0	13.7	84.4	33.5	3.26	2.05	18.8	13.4	23.2	15.3	76.5	22.4	0.272
	3.6	7.40	9.42	22.0	10.9	98.3	38.7	3.23	2.03	21.8	15.5	27.2	18.0	89.4	25.9	0.271
	5.0	9.99	12.7	15.0	7.00	127	49.2	3.16	1.97	28.3	19.7	36.0	23.5	116	32.9	0.267
	6.3	12.3	15.6	11.3	4.94	150	57.0	3.10	1.91	33.3	22.8	43.2	28.0	138	38.1	0.264
	8.0	15.0	19.2	8.25	3.25	174	64.6	3.01	1.84	38.6	25.8	51.4	32.9	160	43.2	0.259
100x50	3.0	6.71	8.54	30.3	13.7	110	36.8	3.58	2.08	21.9	14.7	27.3	16.8	88.4	25.0	0.292
	3.2	7.13	9.08	28.3	12.6	116	38.8	3.57	2.07	23.2	15.5	28.9	17.7	93.4	26.4	0.292
	4.0	8.78	11.2	22.0	9.50	140	46.2	3.53	2.03	27.9	18.5	35.2	21.5	113	31.4	0.290
	5.0	10.8	13.7	17.0	7.00	167	54.3	3.48	1.99	33.3	21.7	42.6	25.8	135	36.9	0.287
	6.3	13.3	16.9	12.9	4.94	197	63.0	3.42	1.93	39.4	25.2	51.3	30.8	160	42.9	0.284
8.0	16.3	20.8	9.50	3.25	230	71.7	3.33	1.86	46.0	28.7	61.4	36.3	186	48.9	0.279	
100x60	3.0	7.18	9.14	30.3	17.0	124	55.7	3.68	2.47	24.7	18.6	30.2	21.2	121	30.7	0.312
	3.6	8.53	10.9	24.8	13.7	145	64.8	3.65	2.44	28.9	21.6	35.6	24.9	142	35.6	0.311
	5.0	11.6	14.7	17.0	9.00	189	83.6	3.58	2.38	37.8	27.9	47.4	32.9	188	45.9	0.307
	6.3	14.2	18.1	12.9	6.52	225	98.1	3.52	2.33	45.0	32.7	57.3	39.5	224	53.8	0.304
	8.0	17.5	22.4	9.50	4.50	264	113	3.44	2.25	52.8	37.8	68.7	47.1	265	62.2	0.299
120x60	3.6	9.66	12.3	30.3	13.7	227	76.3	4.30	2.49	37.9	25.4	47.2	28.9	183	43.3	0.351
	5.0	13.1	16.7	21.0	9.00	299	98.8	4.23	2.43	49.9	32.9	63.1	38.4	242	56.0	0.347
	6.3	16.2	20.7	16.0	6.52	358	116	4.16	2.37	59.7	38.8	76.7	46.3	290	65.9	0.344
	8.0	20.1	25.6	12.0	4.50	425	135	4.08	2.30	70.8	45.0	92.7	55.4	344	76.6	0.339
120x80	5.0	14.7	18.7	21.0	13.0	365	193	4.42	3.21	60.9	48.2	74.6	56.1	401	77.9	0.387
	6.3	18.2	23.2	16.0	9.70	440	230	4.36	3.15	73.3	57.6	91.0	68.2	487	92.9	0.384
	8.0	22.6	28.8	12.0	7.00	525	273	4.27	3.08	87.5	68.1	111	82.6	587	110	0.379
	10.0	27.4	34.9	9.00	5.00	609	313	4.18	2.99	102	78.1	131	97.3	688	126	0.374
150x100	4.0	15.1	19.2	34.5	22.0	607	324	5.63	4.11	81.0	64.8	97.4	73.6	660	105	0.490
	5.0	18.6	23.7	27.0	17.0	739	392	5.58	4.07	98.5	78.5	119	90.1	807	127	0.487
	6.3	23.1	29.5	20.8	12.9	898	474	5.52	4.01	120	94.8	147	110	986	153	0.484
	8.0	28.9	36.8	15.8	9.50	1087	569	5.44	3.94	145	114	180	135	1203	183	0.479
	10.0	35.3	44.9	12.0	7.00	1282	665	5.34	3.85	171	133	216	161	1432	214	0.474
	12.5	42.8	54.6	9.00	5.00	1488	763	5.22	3.74	198	153	256	190	1679	246	0.468



## SQUARE HOLLOW SECTIONS

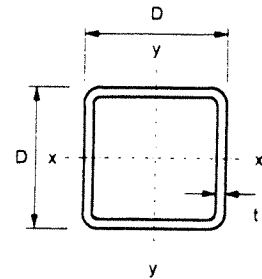

### DIMENSIONS AND PROPERTIES

Designation		Mass per Metre kg	Area of Section A cm <sup>2</sup>	Ratio for Local Buckling d/t <sup>(1)</sup>	Second Moment of Area I cm <sup>4</sup>	Radius of Gyration r cm	Elastic Modulus Z cm <sup>3</sup>	Plastic Modulus S cm <sup>3</sup>	Torsional Constants		Surface Area per Metre m <sup>2</sup>
Size	Thickness								J cm <sup>4</sup>	C cm <sup>3</sup>	
D	D	t	A	d/t <sup>(1)</sup>	I	r	Z	S	J	C	Area per Metre m <sup>2</sup>
mm	mm	mm	cm <sup>2</sup>		cm <sup>4</sup>	cm	cm <sup>3</sup>	cm <sup>3</sup>	cm <sup>4</sup>	cm <sup>3</sup>	m <sup>2</sup>
40x40	2.5	2.89	3.68	13.0	8.54	1.52	4.27	5.14	13.6	6.22	0.154
	3.0	3.41	4.34	10.3	9.78	1.50	4.89	5.97	15.7	7.10	0.152
	3.2	3.61	4.60	9.50	10.2	1.49	5.11	6.28	16.5	7.42	0.152
	4.0	4.39	5.59	7.00	11.8	1.45	5.91	7.44	19.5	8.54	0.150
	5.0	5.28	6.73	5.00	13.4	1.41	6.68	8.66	22.5	9.60	0.147
50x50	2.5	3.68	4.68	17.0	17.5	1.93	6.99	8.29	27.5	10.2	0.194
	3.0	4.35	5.54	13.7	20.2	1.91	8.08	9.70	32.1	11.8	0.192
	3.2	4.62	5.88	12.6	21.2	1.90	8.49	10.2	33.8	12.4	0.192
	4.0	5.64	7.19	9.50	25.0	1.86	9.99	12.3	40.4	14.5	0.190
	5.0	6.85	8.73	7.00	28.9	1.82	11.6	14.5	47.6	16.7	0.187
6.3	8.31	10.6	4.94	32.8	1.76	13.1	17.0	55.2	18.8	0.184	
60x60	3.0	5.29	6.74	17.0	36.2	2.32	12.1	14.3	56.9	17.7	0.232
	3.2	5.62	7.16	15.8	38.2	2.31	12.7	15.2	60.2	18.6	0.232
	4.0	6.90	8.79	12.0	45.4	2.27	15.1	18.3	72.5	22.0	0.230
	5.0	8.42	10.7	9.00	53.3	2.23	17.8	21.9	86.4	25.7	0.227
	6.3	10.3	13.1	6.52	61.6	2.17	20.5	26.0	102	29.6	0.224
8.0	12.5	16.0	4.50	69.7	2.09	23.2	30.4	118	33.4	0.219	
70x70	3.0	6.24	7.94	20.3	59.0	2.73	16.9	19.9	92.2	24.8	0.272
	3.6	7.40	9.42	16.4	68.6	2.70	19.6	23.3	108	28.7	0.271
	5.0	9.99	12.7	11.0	88.5	2.64	25.3	30.8	142	36.8	0.267
	6.3	12.3	15.6	8.11	104	2.58	29.7	36.9	169	42.9	0.264
	8.0	15.0	19.2	5.75	120	2.50	34.2	43.8	200	49.2	0.259
80x80	3.0	7.18	9.14	23.7	89.8	3.13	22.5	26.3	140	33.0	0.312
	3.6	8.53	10.9	19.2	105	3.11	26.2	31.0	164	38.5	0.311
	5.0	11.6	14.7	13.0	137	3.05	34.2	41.1	217	49.8	0.307
	6.3	14.2	18.1	9.70	162	2.99	40.5	49.7	262	58.7	0.304
	8.0	17.5	22.4	7.00	189	2.91	47.3	59.5	312	68.3	0.299
90x90	3.6	9.66	12.3	22.0	152	3.52	33.8	39.7	237	49.7	0.351
	5.0	13.1	16.7	15.0	200	3.45	44.4	53.0	316	64.8	0.347
	6.3	16.2	20.7	11.3	238	3.40	53.0	64.3	382	77.0	0.344
	8.0	20.1	25.6	8.25	281	3.32	62.6	77.6	459	90.5	0.339
100x100	4.0	11.9	15.2	22.0	232	3.91	46.4	54.4	361	68.2	0.390
	5.0	14.7	18.7	17.0	279	3.86	55.9	66.4	439	81.8	0.387
	6.3	18.2	23.2	12.9	336	3.80	67.1	80.9	534	97.8	0.384
	8.0	22.6	28.8	9.50	400	3.73	79.9	98.2	646	116	0.379
	10.0	27.4	34.9	7.00	462	3.64	92.4	116	761	133	0.374
120x120	4.0	14.4	18.4	27.0	410	4.72	68.4	79.7	635	101	0.470
	5.0	17.8	22.7	21.0	498	4.68	83.0	97.6	777	122	0.467
	6.3	22.2	28.2	16.0	603	4.62	100	120	950	147	0.464
	8.0	27.6	35.2	12.0	726	4.55	121	146	1160	176	0.459
	10.0	33.7	42.9	9.00	852	4.46	142	175	1382	206	0.454
	12.5	40.9	52.1	6.60	982	4.34	164	207	1623	236	0.448